

**Specification**

<b>SQ-6038B</b>	Piezo Siren
<b>Resonance Frequency</b>	2.5±0.3Khz
<b>Sound Pressure Level</b> Rated at DC 12 volts @100cm 0dB re 0.0002μbar	110dB min.
<b>Operation Voltage</b>	DC 7-15 volts
<b>Current Drain</b> Rated at DC 12 volts	300 mA
<b>Tone Type*</b>	Sweep from 2-4Khz in 2Hz rate
<b>Case Material</b>	ABS Resin
<b>Mounting Type</b>	Metal Bracket
<b>Color*</b>	Black
<b>Operation Temperature</b>	-20 to 60°C
<b>Storage Temperature</b>	-30 to 70°C

All specification taken typical at 25°C

Operation voltage of DC 24/26/48 volts are available upon request.

\*Other tone type and color can be arranged upon request.

**Dimensions:** dimensions are in mm

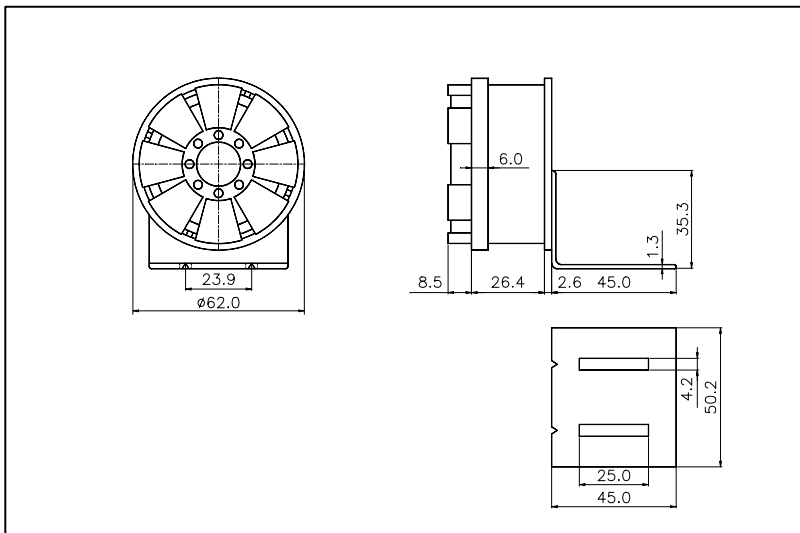
**Application:**

**Burglar alarms**  
**Warning devices**  
**Signaling alarms**  
**Smoke detectors**  
**Swimming pool alarms**  
**Distress signals, etc.**

**Features:**

**High efficiency**  
**Micro and compact construction**  
**Waterproof and dust-proof**  
**Light weight**  
**Low cost**



**S. Square Enterprise Company Limited**  
**Pro-Wave Electronics Corporation**

P.O. Box 1-70 Chung Ho, Taiwan; E-mail: [sales@pro-wave.com.tw](mailto:sales@pro-wave.com.tw); Tel: 886-2-22465101(5 lines), 22459774; Fax: 886-2-22465105

<http://www.s2.com.tw> ; <http://www.prowave.com.tw>